



# ULTRA PONUDA 2025



Ponuda važi do 31. 12. 2025. ili do rasprodaje zalihâ.  
Cene su izražene u RSD.

# KOLICA SA ALATOM

1011FPLUS3 | 625594

## Kolica 940PLUS3 sa 296 alata

964/31SOS, 964/32ASOS, 964/33SOS, 964/28SOS,  
964/34SOS, 964/30SOS

- fiokice sa ugrađenim klizačima za "tiho zatvaranje" sa mogućnošću potpunog otvaranja
- ukupna zapremina fioka: 133 litara
- nosivost svake fiokice pojedinačno: 45 kg

296 kom



~~389.776,00~~

**233.866,00**

**280.639,00**

cena sa pdv-om

3/3



1011KEM1 | 629979

## Kolica sa 106 alata

964/59SOS, 964/60SOS, 964/61SOS

- fiokice sa ugrađenim klizačima za "tiho zatvaranje" sa mogućnošću potpunog otvaranja
- ukupna zapremina fioka: 133 litara
- nosivost svake fiokice pojedinačno: 45 kg

104 kom



~~161.360,00~~

**96.816,00**

**116.179,00**

cena sa pdv-om



1012A | 623942

## Kolica 940EV6 sa 184 alata

- ukupna zapremina fioka: 135 litara
- nosivost svake fioka pojedinačno: 45 kg

964/28SOS, 964/33SOS, 964/50SOS, 964/51SOS, 964/52SOS, 964/53SOS



~~313.144,00~~  
**187.886,00**  
 225.463,00  
 cena sa pdv-om



1011AEV6 | 621756

## Kolica 940EV6 sa garniturom od 325 alata

- ukupna zapremina fioka: 135 litara
- nosivost svake fioka pojedinačno: 45 kg

964/28SOS, 964/29ASOS, 964/32ASOS, 964/30SOS, 964/31SOS, 964/33SOS, 964/34SOS, 940EV6

3/3

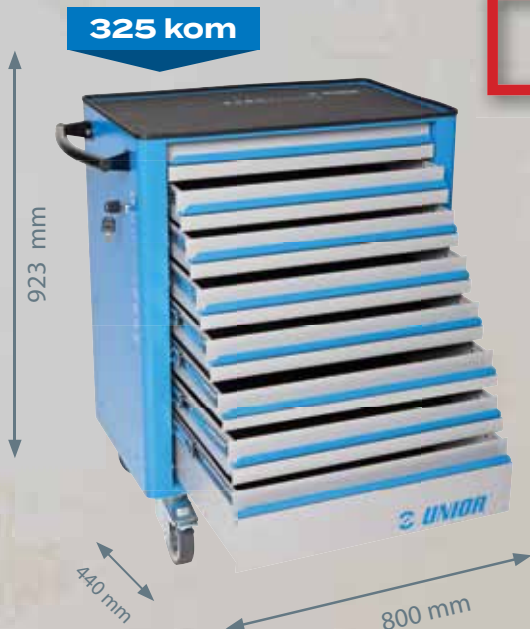

~~391.446,00~~  
**234.868,00**  
 281.842,00  
 cena sa pdv-om



MADE FOR WORK.

# KOLICA SA ALATOM

1011BEV4 | 621757

## Kolica za alat 940EV4 sa garniturom od 192 alata

- osnovne dimenzije sa drškom i točkovima D 780 x Š 440 x V 923 mm
- 7 fioka (5 dimenzija 563x365x70 mm, 2 dimenzije 563x410x150 mm)
- ukupna zapremina fioka: 140 litara
- nosivost svake fioka pojedinačno: 45 kg

964/32ASOS, 964/35SOS, 964/36SOS, 964/37SOS, 940EV4

192 kom



~~239.370,00~~

143.622,00

172.346,00

cena sa pdv-om

3/3



1011CEV4 | 624137

## Kolica za alat 940EV4 sa garniturom od 127 alata

- osnovne dimenzije sa drškom i točkovima D 780 x Š 440 x V 923 mm
- 7 fioka (5 dimenzija 563x365x70 mm, 2 dimenzije 563x410x150 mm)
- ukupna zapremina fioka: 140 litara
- nosivost svake fioka pojedinačno: 45 kg

964/46SOS, 964/47SOS, 964/48SOS, 964/49SOS, 940EV4

127 kom



~~194.376,00~~

116.626,00

139.951,00

cena sa pdv-om

3/3



1011GECO | 625595

## Ekonomik kolica sa 92 alata

- nosivost svake fiokke pojedinačno: 30 kg

964ECO2A, 964ECO6, 964ECO9, 964ECO19, 964ECO5, 940ECO

92 kom



~~128.023,00~~

76.814,00

92.177,00

cena sa pdv-om

1/2



1011DEV6 | 624138

## Kolica za alat 940EV6 sa garniturom od 238 alata

- 8 fioka (7x D 563 x Š 365 x V 70mm, 1x D 563 x Š 383 x V 150mm)
- ukupna zapremina fioka: 135 litara
- nosivost svake fiokke pojedinačno: 45 kg

964/28SOS, 964/29ASOS, 964/30SOS, 964/33SOS, 964/48SOS, 964/49SOS, 940EV6

238 kom



3/3



~~307.800,00~~

184.680,00

221.616,00

cena sa pdv-om

# KOLICA ZA ALAT

940EM1 | 629589

## Kolica za alat Euromotion sa 7 fioka

- statička nosivost kolica bez točkova: 1600 kg
- dinamičko opterećenje kolica: 500 kg
- nosivost svake fioka pojedinačno: 45 kg
- ukupna zapremina fioka: 140 litara

~~81.900,00~~  
49.140,00

58.968,00  
cena sa pdv-om



940PLUS3 | 629590

## Kolica za alat Europlus sa 7 fioka

- statičko opterećenje kolica bez točkova: 2000 kg
- dinamičko opterećenje kolica: 500 kg
- nosivost svake fioka pojedinačno: 45 kg
- ukupna zapremina fioka: 137 litara



~~124.900,00~~  
74.940,00

89.928,00  
cena sa pdv-om

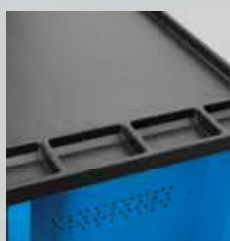

MADE FOR WORK.

940H4 | 629591

## Kolica za alat "HERCULES" sa 7 fioka i 3 police

- statička nosivost kolica bez točkova: 2300 kg
- dinamičko opterećenje kolica: 550 kg
- nosivost prednjih, velikih fioka: 45 kg
- ukupna zapremina fioka: 133 litara



~~129.900,00~~

77.940,00

93.528,00

cena sa pdv-om

940ECO | 617227

## Kolica za alat Economic sa 6 fioka

- 6 fioka (4 dimenzija 498x273x70 mm, 2 dimenzije 498x311x150 mm)
- nosivost svake fioke pojedinačno: 30 kg

četiri točka od kojih jedan sa kočnicom; točkovi prečnika 100 mm, otporni na uticaj ulja i kiselina



~~57.078,00~~

34.247,00

41.096,00

cena sa pdv-om

939/3EV | 620556

## Sanduk za alat Eurovision sa tri fioke

- materijal: premium PLUS čelični lim
- efikasan sistem za zaključavanje
- 3 fioke, dve dimenzija 560x275x70 mm, jedna dimenzija 560x315x150 mm



~~45.327,00~~

27.196,00

32.635,00

cena sa pdv-om

# KOLICA ZA ALAT



940EV4BLOCK | 625000

## Kolica za alat EUROVISION sa sigurnosnim "BLOCK" sistemom sa 7 fioka

- 7 fioka (5 dimenzija 563x365x70 mm, 2 dimenzije 563x410x150 mm)
- statička nosivost kolica bez točkova: 1600 kg
- dinamičko opterećenje kolica: 500 kg
- nosivost svake fioka pojedinačno: 45 kg
- ukupna zapremina fioka: 140 litara

97.599,00  
58.559,00

70.271,00  
cena sa pdv-om

940EV6 | 619886

## Kolica za alat Eurovision sa 8 fioka

- 8 fioka (7x D 563 x Š 365 x V 70mm, 1x D 563 x Š 383 x V 150mm)
- statička nosivost kolica bez točkova: 1600 kg
- dinamičko opterećenje kolica: 500 kg
- nosivost svake fioka pojedinačno: 45 kg
- ukupna zapremina fioka: 135 litara

96.110,00  
57.666,00

69.199,00  
cena sa pdv-om

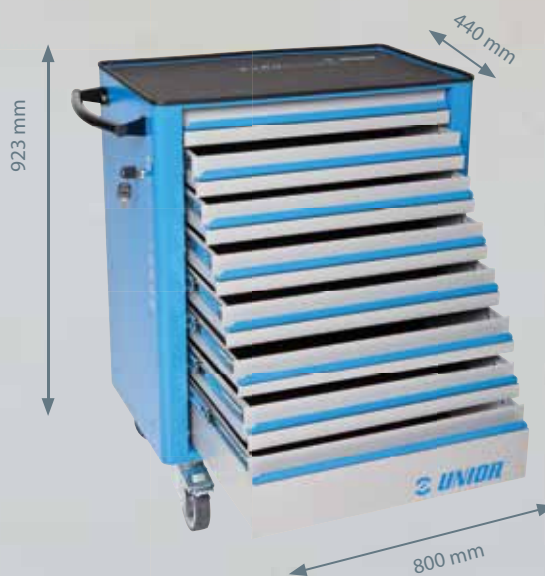

## PRIBOR

940ES9 | 608973

### Ploča drvena

- L: 690 mm, B: 430 mm, H: 16 mm



10.220,00  
7.665,00

9.198,00  
cena sa pdv-om



940ES8 | 608972

### Plastična zaštitna obloga za kolica

- L: 705 mm, B: 440 mm, H: 22 mm



2.936,00  
2.202,00

2.642,00  
cena sa pdv-om

940ES7 | 608971

### Nosač boce za kolica

- L: 350 mm, B: 100 mm, H: 70 mm



1.641,00  
1.231,00

1.477,00  
cena sa pdv-om

940ES3 | 608925

### Set od 4 pregrade za kolica 940ECO

- L: 377 mm, B: 2.2 mm, H: 65 mm



1.139,00  
854,00

1.025,00  
cena sa pdv-om

940ES3A | 622597

### Garnitura pregrada za male fioka za kolica 940E i 940EV

- L: 557 mm, B: 375 mm, H: 65 mm

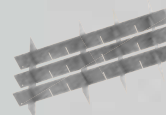

2.396,00  
1.797,00

2.156,00  
cena sa pdv-om



990ND6 | 625622

## Orman za alat - 6 fioka

- 6 fioka (4 dim. 374x570x70mm, 1 dim. 374x605x150mm i 1 dim. 374x605x230mm)
- ukupna zapremina fioka: 145 litara
- maksimalna nosivost svake fioka: 50 kg



~~95.426,00~~

**62.027,00**

**74.432,00**

cena sa pdv-om

ekstra dugačke fioka

990BIN | 625655

## Dodatna oprema za modularni radni sto

- sa 2 fioka
- Najniža fioka ima 2 podeljena dela za smeće, ukupne zapremine 50 litara; prvi deo (odvojena posuda) ima mogućnost da smeće prođe kroz vrata na prednjoj strani fioka.
- U gornju fioku se može staviti rolna papirna max. fi 270 mm i max. dužine 380 mm. Na zadnjoj strani fioka postoji i mesto za rezervnu rolnu papira.



~~89.037,00~~

**53.422,00**

**64.106,00**

cena sa pdv-om

990CA

## Orman sa rolo vratima

- dužina 1000 mm sa 20 kukica, dužina 1500 mm sa 30 kukica
- bravica sa ključem i priveskom



cena sa pdv-om

|        |              |                       |           |           |
|--------|--------------|-----------------------|-----------|-----------|
| 625668 | 1000x125x740 | <del>87.736,00</del>  | 52.642,00 | 63.170,00 |
| 612330 | 1500x125x740 | <del>100.031,00</del> | 60.019,00 | 72.023,00 |

990TWS | 625633

## Nerđajuća zaštita za dasku



cena sa pdv-om

|        |                 |                      |           |           |
|--------|-----------------|----------------------|-----------|-----------|
| 625633 | 1500 x 753 x 41 | <del>26.294,00</del> | 17.091,00 | 20.509,00 |
| 625634 | 2000 x 753 x 41 | <del>33.725,00</del> | 21.921,00 | 26.305,00 |

- šper ploča od bukovog drveta
- zaštićena sa ekološkim zaštitinim slojem



990TW

## Drvena daska za radni sto

cena sa pdv-om

|        |                 |                      |           |           |
|--------|-----------------|----------------------|-----------|-----------|
| 625630 | 1500 x 750 x 40 | <del>29.280,00</del> | 19.032,00 | 22.838,00 |
| 625631 | 2000 x 750 x 40 | <del>40.906,00</del> | 26.589,00 | 31.907,00 |

990WD6 | 625620

## Orman za alat - 6 fioka

- 6 fioka (4 dim. 564x570x70mm, 1 dim. 564x605x150mm i 1 dim. 564x605x230mm)
- ukupna zapremina svih fioka: 220 litara
- maksimalna nosivost svake fioka: 50 kg

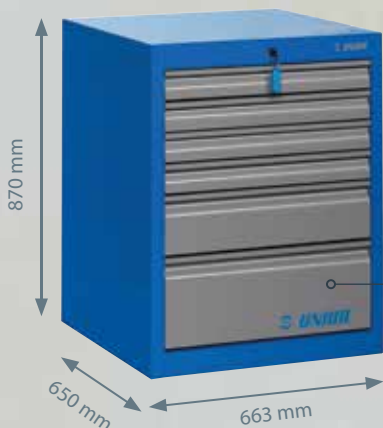

107.605,00

69.943,00

83.932,00

cena sa pdv-om

fioka sa kliznim vođicama  
mogu se izvući u potpunosti  
radi pregleda sadržaja

990WD8 | 625621

## Orman za alat - 8 fioka

- 8 fioka (7 x D 564 x Š 570 x V 70mm, 1x D 564 x Š 605 x V 150mm)
- ukupna zapremina svih fioka: 208 litara
- maksimalna nosivost svake fioka: 50 kg

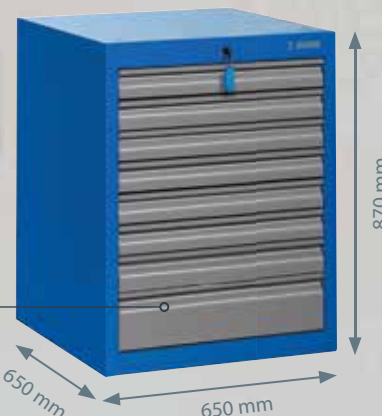

118.942,00

77.312,00

92.774,00

cena sa pdv-om

ukupna zapremina  
svih fioka: 208 litara

990WDD2 | 625625

## Orman za alat - 2 fioka i vrata

- 2 fioka dimenzija 564x570x70mm
- ukupna zapremina svih fioka: 45 litara
- maksimalna nosivost svake fioka: 50 kg

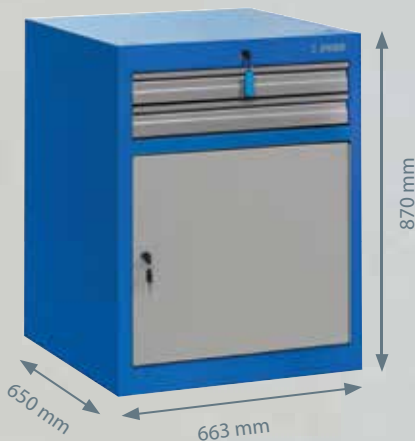

78.956,00

51.321,00

61.585,00

cena sa pdv-om

990ND8 | 625623

## Orman za alat - 8 fioka

- 8 fioka (7 dimenzija 374x570x70mm, 1 dim. 374x605x150mm)
- ukupna zapremina svih fioka: 128 litara
- maksimalna nosivost svake fioka: 50 kg

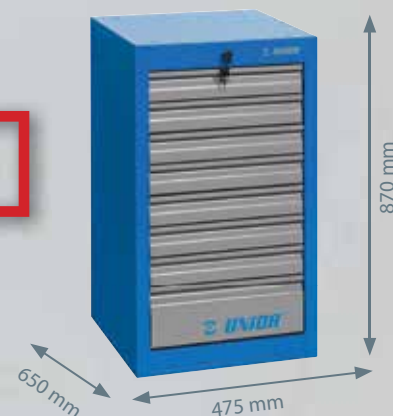

105.078,00

68.301,00

81.961,00

cena sa pdv-om

990NDD2 | 625624

## Orman za alat - 2 fioka i vrata

- 2 fioka dimenzija 374x570x70mm
- sa vratima
- ukupna zapremina svih fioka: 30 litara
- maksimalna nosivost svake fioka: 50 kg

70.615,00

45.900,00

55.080,00

cena sa pdv-om



990PNE | 625646

## Element sa dovodom el.energije za modularni radni sto

- Element sa dovodom el.energije za modularni radni sto - sa 2 kalema/namotaja (za električni kabal i za pneum. crevo) sa povratnom oprugom



121.668,00

79.084,00

94.901,00

cena sa pdv-om

990MA1 | 625751

## UNIOR Modularni radni sto - modul A1

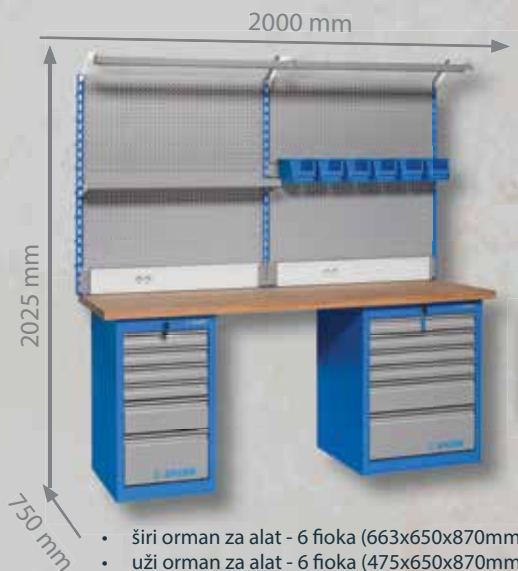

- širi orman za alat - 6 fioka (663x650x870mm)
- uži orman za alat - 6 fioka (475x650x870mm)

~~384.379,00~~  
**245.883,00**

**295.060,00**  
cena sa pdv-om

994 | 612208

## Mobilni pult

- 2 fioka D 563 x Š 365 x V 70mm
- nosivost svake fioka pojedinačno: 45 kg

~~79.718,00~~  
**47.831,00**

**57.397,00**  
cena sa pdv-om



990MA6 | 625756

## UNIOR Modularni radni sto - modul A6



~~210.706,00~~  
**133.618,00**

**160.342,00**  
cena sa pdv-om

- uži orman za alat - 6 fioka (475x650x870mm)

990MA3 | 625753

## UNIOR Modularni radni sto - modul A3

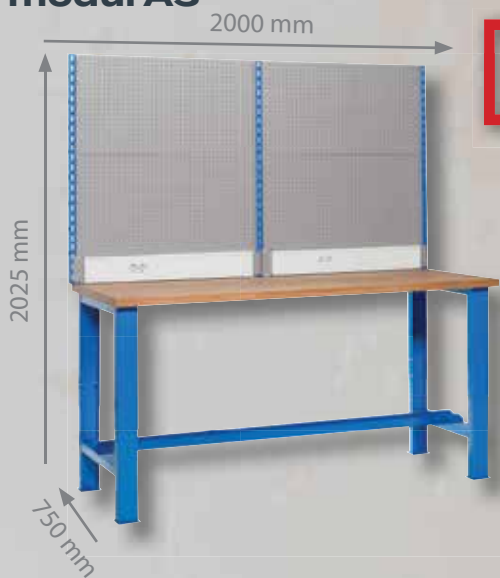

~~168.948,00~~  
**118.264,00**

**141.917,00**  
cena sa pdv-om

990MA16 | 627607

## UNIOR Modularni radni sto - modul A16



~~256.488,00~~  
**162.650,00**

**195.180,00**  
cena sa pdv-om

# RADNI STOLOVI

990MA10 | 625760

## UNIOR Modularni radni sto - modul A10

- širi orman za alat - 6 fioka (663x650x870mm)
- širi orman za alat - 8 fioka (663x650x870mm)

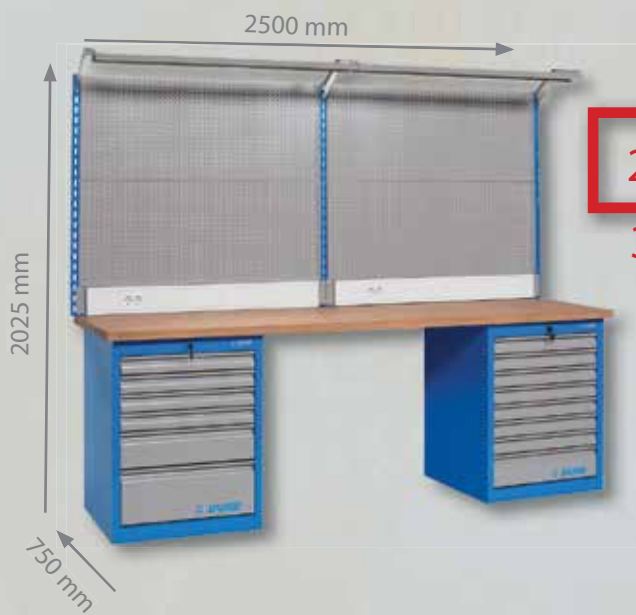

~~420.497,00~~

**287.167,00**

**344.600,00**

cena sa pdv-om

990MA11 | 625761

## UNIOR Modularni radni sto - modul A11

- širi orman za alat - 6 fioka (663x650x870mm)
- užji orman za alat - 6 fioka (475x650x870mm)



~~333.386,00~~

**216.701,00**

**260.041,00**

cena sa pdv-om

990MA7 | 625757

## Sto radni modularni A7



~~173.233,00~~

**118.306,00**

**141.967,00**

cena sa pdv-om

990MA18 | 627656

## Sto radni modularni A18



~~460.277,00~~

**276.166,00**

**331.399,00**

cena sa pdv-om

MADE FOR WORK.

990MA14 | 627544

## Sto radni modularni A14

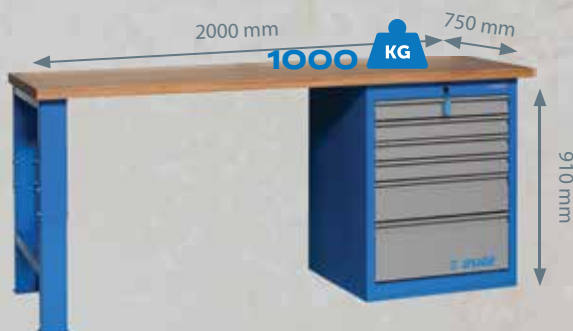

~~168.402,00~~  
101.041,00

121.249,00  
cena sa pdv-om

990MA13 | 626731

## Sto radni modularni A13



~~233.153,00~~  
139.892,00

167.870,00  
cena sa pdv-om

990MA15 | 627545

## Sto radni modularni A15

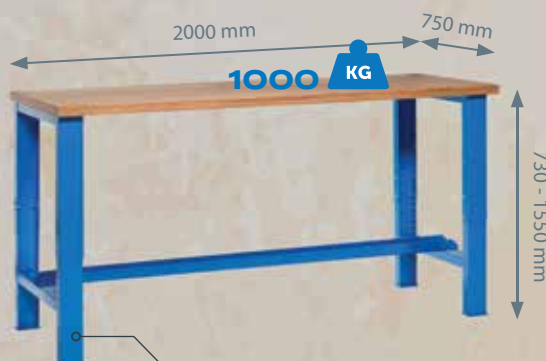

sa potpornim nogama,  
podesivim po visini

~~80.750,00~~  
48.450,00

58.140,00  
cena sa pdv-om

990MA12 | 626730

## Sto radni modularni A12



~~367.497,00~~  
220.498,00

264.598,00  
cena sa pdv-om

MADE FOR WORK.

## Za profesionalce

## Odgovarajući izbor sastava garnitura

## Jednostavan izbor

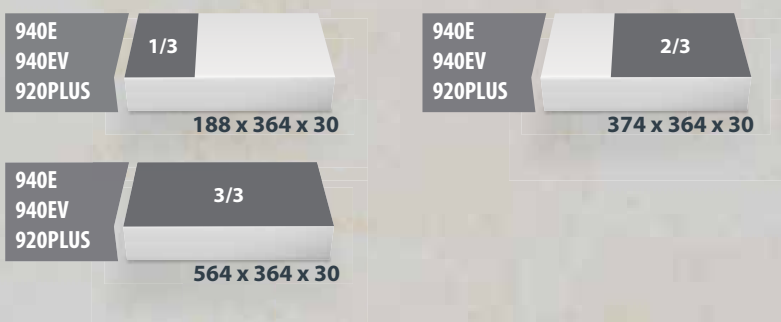

964/31SOS | 621390

### Garnitura od 79 alata

□ 192/2TX (TX 20, TX 25, TX 27, TX 30, TX 40, TX 4, TX 50, TX 55, TX 60),  
 □ 192/2TXL (TX 20, TX 25, TX 27, TX 30, TX 40, TX 45, TX 50, TX 55, TX 60),  
 □ 191/1 (E 10, E 11, E 12, E 14, E 16, E 18, E 20, E 22, E 24),  
 □ 192/2ZX (M 5, M 6, M 8, M 10, M 12, M 14), □ 192/2ZXL (M 6, M 8, M 10, M 12, M 14),  
 □ 192/2HX (5, 6, 7, 8, 9, 10, 12, 14), □ 192/2HXL (5x64, 6x64, 7x64, 8x64, 10x64, 12x64),  
 □ 190/1 12p (10, 11, 12, 13, 14, 15, 16, 17, 18, 19, 20, 21, 22, 24, 27, 30, 32),  
 □ 186.4/2 (16, 19, 21), □ 641/6 (2, 3, 4, 5, 6, 8), 263 (1/2"/40-200 Nm)

~~83.002,00~~

**53.951,00**

**64.741,00**

cena sa pdv-om



79 kom

3/3

964/53SOS | 623995

### Garnitura od 22 alata

□ 197.1/1 (3/4"x500), □ 197.3/1 (3/4"), □ 197.4/1 (3/4"x200, 3/4"x400),  
 □ 197/1 6p (22, 24, 27, 30, 32, 36, 38, 41, 46, 50),  
 197/2AHX (14, 17, 19, 22), □ 197.7/1 (3/4" - 1/2"), 190.7/2 (1/2"x3/4"),  
 2035, 2087

~~56.701,00~~

**34.021,00**

**40.825,00**

cena sa pdv-om



22 kom

3/3

964/28SOS | 621387

## Garnitura od 60 alata

**110/1** (6 x 7, 8 x 9, 10 x 11, 12 x 13, 14 x 15, 16 x 17, 18 x 19, 20 x 22, 21 x 23, 24 x 27, 25 x 28, 30 x 32), 
 **120/1** (6, 7, 8, 9, 10, 11, 13, 14, 15, 16, 17, 18, 19, 20, 21, 22, 24, 27), 
 **180/1** (6 x 7, 8 x 9, 10 x 11, 12 x 13, 14 x 15, 16 x 17, 18 x 19, 20 x 22, 21 x 23, 24 x 26, 25 x 28, 27 x 32), 
 **220/3SPH, 220/7TXPH** (TR8 - TR40x9)

3/3

45.154,00

29.350,00

35.220,00

cena sa pdv-om

60 kom

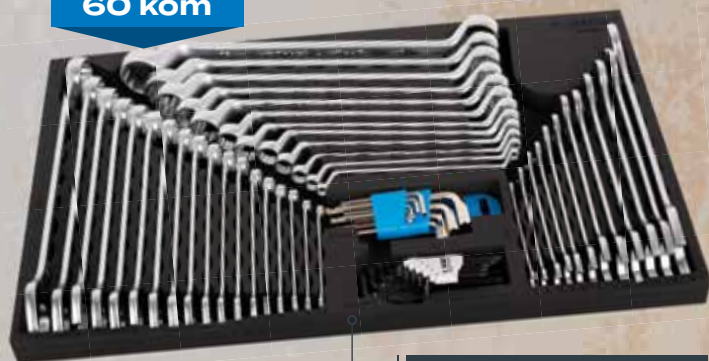

obuhvatni (okasti) deo sa LIFE profilom

964VDE3BI | 629983

## Garnitura od 11 alata

**406/1VDEBI** (180), **461/1VDEBI** (160), **472/1VDEBI** (160), 
 **478/1VDEBI** (160), **466/1VDEBI** (180), **580/1VDEBI** (170), 
 **514/1BI** (160), **447/1VDEBI** (240), **508/1VDEBI** (170), 
 **582/3BI** (145), **512/1VDEBI** (170)

3/3

33.310,00

19.986,00

23.983,00

cena sa pdv-om

11 kom



964VDE8A | 621800

## Garnitura od 11 alata

**603VDEBTBI** (0.4 x 2.5x75, 0.5 x 3.0x100, 0.6 x 3.5x100, 0.8 x 4.0x100, 1.0 x 4.5x125, 1.0 x 5.5x125, 1.2 x 6.5x150, 1.2 x 8.0x175, 1.6 x 10.0x200), 
 **630VDE** (0.5 x 3.0x140, 0.6 x 3.5x180)

2/3

8.640,00

6.480,00

7.776,00

cena sa pdv-om

11 kom



# GARNITURE ALATA



964/32ASOS | 623936

## Garnitura od 14 alata

406/1BI (180), 430/3 (250), 447/1HPP (240),  
 466/1BI (180), 514/1BI (160), 512/1BI (200),  
 532PLUS/1DP (180x19 - 60), 534PLUS/1DP (180x19 - 60),  
 536PLUS/1DP (180x19 - 60), 538PLUS/1DP (180x19 - 60),  
 642/6 (5), 660/6 (200), 812 (400),  
 820A (40), VL964/32ASOS (564x364x30)

29.440,00  
**19.136,00**

22.963,00  
 cena sa pdv-om

964/30SOS | 621389

## Garnitura od 96 alata



savitljiva ručka omogućava rad pod uglom od 90° sa nagibom od 22,5°

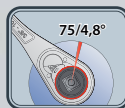

mehanizam sa 75 zuba radni ugao 4,8°

61.689,00  
**40.098,00**

48.118,00  
 cena sa pdv-om

188/2 6P (4, 4.5, 5, 5.5, 6, 7, 8, 9, 10, 11, 12, 13), 189/2 (E 4, E 5, E 6, E 7, E 8, E 10, E 11), 187/2HX (3, 4, 5, 6, 7), 187/2TX (TX 8, TX 10, TX 15, TX 20, TX 25, TX 27, TX 30, TX 40), 187/2SL (0.8 x 4, 1.0 x 5.5, 1.2 x 7), 187/2PH (PH 1, PH 2, PH 3), 188.1/1ABI (1/4"), 188.2/2BI (1/4"), 188.3/2 (1/4"), 188.4/2 (1/4"x55, 1/4"x150), 188.6/2 (1/4"), 188.7/2 (1/4" - 3/8"), 188.8 (1/4"), 238/1 6P (6, 7, 8, 9, 10, 11, 12, 13, 14, 15, 16, 17, 18, 19, 20, 21, 22), 238.1/1FBI (3/8"), 238.2/1BI (3/8"), 238.3/1 (3/8"), 238.4/2 (3/8"x45, 3/8"x75), 238.4/1 (3/8"x125, 3/8"x250), 238.6/1 (3/8"), 238.7/1 (3/8" - 1/2"), 190/1 6P (10, 11, 12, 13, 14, 15, 16, 17, 18, 19, 20, 21, 22, 23, 24, 27, 30, 32), 190.1/1ABI (1/2"), 190.2/1BI (1/2"x380), 190.3/1 (1/2"), 190.4/1 (1/2"x250, 1/2"x125), 190.6/2 (1/2"), VL964/30SOS (564x364x30)

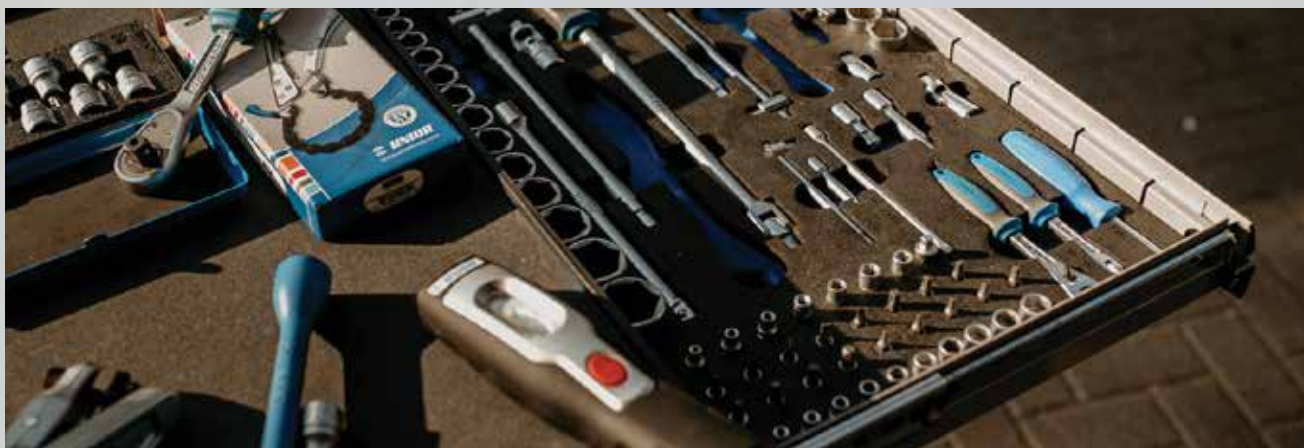

MADE FOR WORK.



964/34SOS | 621393

## Garnitura od 18 alata

18 kom



18.817,00

12.231,00

14.677,00  
cena sa pdv-om

3/3

— 193HXS (2.5, 3, 4, 5, 6, 8, 10), — 193TX (TX 10, TX 15, TX 20, TX 25, TX 27, TX 30, TX 40, TX 45), — 760H1/2S (200), — 764H1/2S (200), — 556B (160x18), — VL964/34SOS (564x364x30)

930 | 601996

## Garnitura alata u kutiji 912/5

80 kom



90.432,00

54.259,00

65.111,00  
cena sa pdv-om

110/1CB, 180/1CB, — 212/2 (19), 220/3PB, — 186.4/2 (21), — 238.1/1FBI (3/8"), — 238.4/2 (3/8"x45, 3/8"x75), — 190.1/1ABI (1/2"), — 190.2/1BI (1/2"x380), — 190.3/1 (1/2"), — 190.4/1 (1/2"x125, 1/2"x250), — 190.6/2 (1/2"), — 190/1 6P (10, 11, 12, 13, 14, 15, 16, 17, 18, 19, 20, 21, 22, 23, 24, 27, 30, 32), — 300/2 (400 (2x)), — 405/1BI (180), — 430/3 (175), — 447/1HPP (240), — 461/1BI (160), — 506/1BI (140), — 514/1BI (160), — 563R/7PR (280), — 605TBI (0.8 x 4.0x100, 1.0 x 5.5x125, 1.2 x 6.5x150, 1.2 x 8.0x175), — 615TBI (PH 2x100, PH 3x150), — 631 (6 - 12), — 812 (500), 912/5 (560x210x225)

964/36SOS | 621395

## Garnitura od 88 alata

88 kom



55.752,00

36.239,00

43.487,00

cena sa pdv-om

3/3

— 188/2 6P (4, 4.5, 5, 5.5, 6, 7, 8, 9, 10, 11, 12, 13), — 189/2 (E 4, E 5, E 6, E 7, E 8, E 10, E 11), — 187/2HX (3, 4, 5, 6, 7), — 187/2TX (TX 8, TX 10, TX 15, TX 20, TX 25, TX 27, TX 30, TX 40), — 187/2SL (0.8 x 4, 1.0 x 5.5, 1.2 x 7), — 187/2PH (PH 1, PH 2, PH 3), — 188.1/1ABI (1/4"), — 188.2/2BI (1/4"), — 188.3/2 (1/4"), — 188.4/2 (1/4"x55, 1/4"x150), — 188.6/2 (1/4"), — 188.7/2 (1/4" - 3/8"), — 188.8 (1/4"), — 190/1 6P (10, 11, 12, 13, 14, 15, 16, 17, 18, 19, 20, 21, 22, 23, 24, 27, 30, 32), — 191/1 (E 10, E 11, E 12, E 14), — 192/2HX (6, 7, 8, 9, 10, 12), — 192/2TX (TX 30, TX 40, TX 45, TX 50), — 192/2ZXL (M 6, M 8, M 10, M 12), — 190.1/1ABI (1/2"), — 190.2/1BI (1/2"x380), — 190.3/1 (1/2"), — 190.4/1 (1/2"x250, 1/2"x125), — 190.6/2 (1/2"), — VL964/36SOS (564x364x30)

911/5 | 601909

## Kutija za alat petodelna

- A: 460, B: 210, C: 220 mm
- L: 500 mm

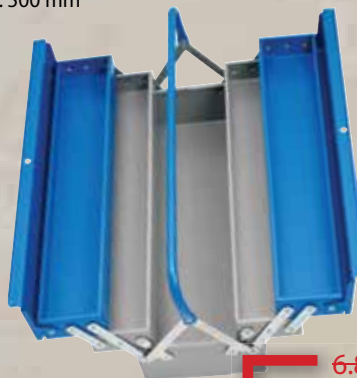

6.820,00

5.115,00

6.138,00

cena sa pdv-om



931 | 601995

## Garnitura alata u kutiji 912/5

111 kom



~~115.168,00~~

69.101,00

82.921,00  
cena sa pdv-om

110/1CB, 125/1CB, 180/1CB, 220/2CB, 220/3PB, 186.4/2 (21), 238.1/1FBI (3/8"), 238.4/2 (3/8"x45, 3/8"x75), 190.1/1ABI (1/2"), 190.2/1BI (1/2"x380), 190.3/1 (1/2"), 190.4/1 (1/2"x125, 1/2"x250), 190.6/2 (1/2"), 190/1 6P (10, 11, 12, 13, 14, 15, 16, 17, 18, 19, 20, 21, 22, 23, 24, 27, 30, 32), 300/2 (400 (2x)), 425/4A (1.5 - 6x240), 406/1BI (180), 445/1BI (240), 447/1HPP (240), 461/1BI (160), 514/1BI (160), 563R/7PR (280), 605TBI (0.8 x 4.0x100, 1.0 x 5.5x125, 1.2 x 6.5x150, 1.2 x 8.0x175), 615TBI (PH 1x80, PH 2x100, PH 4x200), 626TBI (PH 2x25), 627TBI (0.8 x 4.0x25), 631 (6 - 12), 640/6 (3, 4), 642/6 (3), 660/6 (150, 200), 670/6 (150), 812 (500), 912/5 (560x210x225)

971/1BI | 608540

## Alat u koferu

51 kom



~~74.575,00~~

44.745,00

53.694,00  
cena sa pdv-om

1000S, 969S (500x420x200)

110/1CT | 615465

## Ključevi viljuškasti u torbici

8 kom



~~6.027,00~~

4.219,00

5.063,00  
cena sa pdv-om

110/1 (6 x 7, 8 x 9, 10 x 11, 12 x 13, 14 x 15, 16 x 17, 18 x 19, 20 x 22)

12 kom

kovan, u potpunosti kaljen i ojačan



7.929,00  
5.550,00

110/1CB | 600106

## Ključevi viljuškasti u kartonskoj kutiji

110/1 (6 x 7, 8 x 9, 10 x 11, 12 x 13, 14 x 15, 16 x 17, 18 x 19, 20 x 22, 21 x 23, 24 x 26, 25 x 28, 27 x 32)

6.660,00  
cena sa pdv-om

15.129,00  
9.834,00

12 kom



11.801,00  
cena sa pdv-om

110/2VDEDP | 612676

## Ključevi viljuškasti izolovani u kartonskoj kutiji

110/2VDEDP (10, 11, 12, 13, 14, 15, 17, 19, 22, 24)

12.096,00  
8.467,00

12 kom



10.160,00  
cena sa pdv-om

180/1CB | 600542

## Ključevi okasti u kartonskoj kutiji

180/1 (6 x 7, 8 x 9, 10 x 11, 12 x 13, 14 x 15, 16 x 17, 18 x 19, 20 x 22, 21 x 23, 24 x 26, 25 x 28, 27 x 32)

8 kom



3.950,00  
2.765,00

16.255,00  
9.753,00

10 kom



11.704,00  
cena sa pdv-om

180/2VDEDP | 612677

## Ključevi okasti izolovani u kartonskoj kutiji

180/2VDEDP (10, 11, 12, 13, 14, 15, 17, 19, 22, 24)

110/1CS | 602844

## Ključevi viljuškasti u kartonskoj kutiji

110/1 (6 x 7, 8 x 9, 10 x 11, 12 x 13, 14 x 15, 16 x 17, 18 x 19, 20 x 22)

3.318,00  
cena sa pdv-om

26 kom



28.401,00  
17.041,00

9.946,00  
5.968,00

10 kom



7.162,00  
cena sa pdv-om

193TXCB | 608880

## Ključevi sa TX profilom sa T-ručicom, dvostrani

193TX (TX6, TX8, TX10, TX15, TX20, TX25, TX27, TX30, TX40, TX45)

120/1CB | 600384

## Ključevi viljuškasto-okasti dugi u kartonskoj kutiji

120/1 (6, 7, 8, 9, 10, 11, 12, 13, 14, 15, 16, 17, 18, 19, 20, 21, 22, 23, 24, 25, 26, 27, 28, 29, 30, 32)

20.449,00  
cena sa pdv-om

# GARNITURE ALATA

11 kom



11.837,00  
7.102,00

8.522,00  
cena sa pdv-om

120/1CB | 629610

**Ključevi viljuškasto-okasti dugi u kartonskoj kutiji**

120/1 (8, 10, 12, 13, 14, 17, 19, 22, 24, 30, 32)

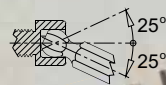

9 kom



2.531,00  
1.898,00

2.278,00  
cena sa pdv-om

220/3SLPH | 608534

**Ključevi imbus, loptasti, dugi, na plastičnom držaču**

220/3SL (1.5, 2, 2.5, 3, 4, 5, 6, 8, 10)

26 kom



26.095,00  
15.657,00

18.788,00  
cena sa pdv-om

125/1CB | 602098

**Ključevi viljuškasto-okasti u kartonskoj kutiji**

125/1 (6, 7, 8, 9, 10, 11, 12, 13, 14, 15, 16, 17, 18, 19, 20, 21, 22, 23, 24, 25, 26, 27, 28, 29, 30, 32)

10 kom

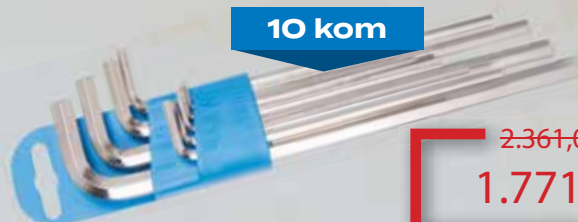

2.361,00  
1.771,00

2.125,00  
cena sa pdv-om

220/3LPH | 617080

**Ključevi imbus dugi na plastičnom držaču**

220/3L (1.5, 2, 2.5, 3, 4, 5, 6, 8, 10, 12)

8 kom



4.988,00  
3.741,00

4.489,00  
cena sa pdv-om

125/1CS | 603711

**Ključevi viljuškasto-okasti u kartonskoj kutiji**

125/1 (8, 9, 10, 12, 13, 14, 17, 19)

3.074,00  
2.306,00

2.767,00  
cena sa pdv-om

9 kom



TX8 - TX40

220/7TXNPH | 617077

**Ključevi imbus sa TX profilom na plastičnom držaču**

160/6CB | 623080

**Ključevi viljuškasto-okasti sa čegrtaljkom u kartonskoj kutiji**

160/6 (8, 10, 13, 16, 17, 18, 19, 22, 24)

9 kom



19.133,00  
11.480,00

13.776,00  
cena sa pdv-om

• napomena: artikal 160/2CB ćemo isporučivati dok ga imamo na zalihama, a nakon toga možete očekivati ovaj izmenjeni model 160/6CB.

183/2CT | 615467

## Ključevi okasti otvoreni u torbici



183/2 (8 x 10, 11 x 13, 12 x 14, 16 x 18, 17 x 19, 22 x 24)

6.596,00  
4.947,00

5.936,00  
cena sa pdv-om

mehanizam sa 40 zuba radni ugao 9°

16 kom



10.581,00  
6.349,00

7.619,00  
cena sa pdv-om

188BI | 611996



## Ključevi nasadni, prihvat 1/4", u metalnoj kutiji

188/2 6P (4, 4.5, 5, 5.5, 6, 7, 8, 9, 10, 11, 13), 188.1/1ABI (1/4"), 188.2/2BI (1/4"), 188.3/2 (1/4"), 188.4/2 (1/4" x 55, 1/4" x 150), 981K1/4 (1/4"x197x105x38)

16.952,00

10.171,00

12.205,00  
cena sa pdv-om

10 kom



231/4PB2 | 612507

## Ključevi nasadni IMPACT, prihvat 1/2", u plastičnoj kutiji

231/4L6P (15, 17, 18, 19, 21, 22, 24, 27, 30), 231.4/4 (1/2"x75), 238.8/4 (10 - 14, 15 - 32)

24 kom



19.090,00

12.409,00

14.891,00  
cena sa pdv-om

19.485,00

11.691,00

14.029,00  
cena sa pdv-om

44 kom



188B | 615150



## Ključevi nasadni i nastavci, prihvat 1/4", u metalnoj kutiji

188/2 6p (4, 4.5, 5, 5.5, 6, 7, 8, 9, 10, 11, 12, 13, 14), 188.1/1ABI (1/4"), 188.3/2 (1/4"), 188.4/2 (1/4" x 55, 1/4" x 150), 188.6/2 (1/4"), 187/2PH (PH 1, PH 2, PH 3), 187/2SL (0.8 x 4, 1.0 x 5.5, 1.2 x 7), 187/2HX (3, 4, 5, 6, 7), 187/2TX (TX 8, TX 10, TX 15, TX 20, TX 25, TX 27, TX 30, TX 40), 189/2 (E 4, E 5, E 6, E 7, E 8, E 10, E 11), 981K3/8 (3/8"x321x198x54)

239A | 612509

## Ključevi nasadni, prihvat 3/8", u metalnoj kutiji

238/1 6P (6, 7, 8, 9, 10, 11, 12, 13, 14, 15, 16, 17, 18, 19, 20, 21, 22), 238.3/1 (3/8"), 238.4/1 (3/8"x250, 3/8"x125), 238.6/1 (3/8"), 238.1/1ABI (3/8"), 238.2/1BI (3/8"), 238.7/1 (3/8" - 1/2")

# GARNITURE ALATA

263

## Moment ključ

- tačnost: +/-3%
- mikro skala za jednostavno podešavanje bez grešaka
- dvojna skala: lb.ft i Nm
- mogućnost fiksiranja željenog momenta
- brzo podešavanje momenta – dovoljno je osam (8) okreta da se „pokrije“ cela merna skala
- obloga na ručki: dvokomponentni materijal
- radni ugao: 5°



cena sa pdv-om

|        |                   |                      |           |           |
|--------|-------------------|----------------------|-----------|-----------|
| 626765 | 3/8" / 12 - 60Nm  | <del>24.511,00</del> | 14.707,00 | 17.648,00 |
| 626766 | 1/2" / 40 - 200Nm | <del>25.677,00</del> | 15.406,00 | 18.487,00 |
| 626767 | 1/2" / 60 - 340Nm | <del>40.683,00</del> | 24.410,00 | 29.292,00 |



MADE FOR WORK.

15 kom



~~8.132,00~~  
4.879,00

5.855,00  
cena sa pdv-om

190H12P15 | 622635

**Ključevi nasadni, prihvat 1/2",  
na držaču**

☐ 190/1 12p (10, 12, 13, 14, 15, 16, 17, 18, 19, 21, 22, 24, 27, 30, 32), 190H (450)

7 kom



~~7.425,00~~  
5.198,00

6.238,00  
cena sa pdv-om

193TXCS | 607888



**Ključevi sa TX profilom sa T-ručicom,  
dvostrani, u kartonskoj kutiji**

— 193TX (TX 10, TX 15, TX 20, TX 25, TX 30, TX 40, TX 45)

23 kom



mehanizam sa 75 zuba  
radni ugao 4,8°  
sigurnosni sistem fiksiranja

23.633,00  
14.180,00

17.016,00  
cena sa pdv-om

190BI6P23 | 612779



**Ključevi nasadni, prihvat 1/2", u metalnoj kutiji**

190/1 6P (10, 11, 12, 13, 14, 15, 16, 17, 18, 19, 20, 21, 22, 23, 24, 27, 30, 32), 190.1/1ABI (1/2"), 190.3/1 (1/2"), 190.4/1 (1/2"x125, 1/2"x250), 190.6/2 (1/2")

24 kom



26.691,00  
16.015,00

19.218,00  
cena sa pdv-om

190BI6P24 | 611939



**Ključevi nasadni, prihvat 1/2", u metalnoj kutiji**

190/1 6P (10, 11, 12, 13, 14, 15, 16, 17, 18, 19, 20, 21, 22, 23, 24, 27, 30, 32), 190.1/1ABI (1/2"), 190.2/1BI (1/2" x 380), 190.3/1 (1/2"), 190.4/1 (1/2" x 125, 1/2" x 250), 190.6/2 (1/2")

14 kom



51.163,00

30.698,00

36.838,00  
cena sa pdv-om

197MB2 | 600954



**Ključevi nasadni, prihvat 3/4", u metalnoj kutiji**

197/1 6P (22, 24, 27, 30, 32, 36, 38, 41, 46, 50), 197.1/1 (3/4" x 500), 197.3/1 (3/4"), 197.4/1 (3/4" x 400, 3/4" x 200)

12 kom



99.022,00

59.413,00

71.296,00  
cena sa pdv-om

199MB1 | 603095



**Ključevi nasadni, prihvat 1", u metalnoj kutiji**

199/1 6P (46, 50, 55, 60, 65, 70, 75, 80), 199.1/1 (1"), 199.3/1 (1"), 199.4/1 (1" x 400, 1" x 200)

# ŠIROK ASORTIMAN KLEŠTA ZA RAZLIČITE NAMENE



406/1BI | 607871

**Klešta kombinovana**

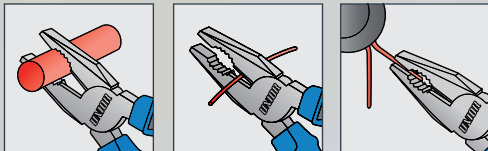

1.790,00  
**1.253,00**

1.504,00  
cena sa pdv-om

406/4G | 608675

**Klešta kombinovana**



1.360,00  
**952,00**

1.142,00  
cena sa pdv-om

442/1HYPO | 611780

**Klešta papagaj podešavajuća "HYPO"**

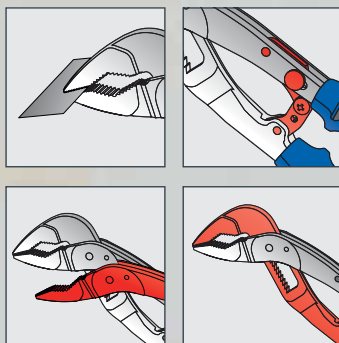

3.726,00  
**2.795,00**

3.354,00  
cena sa pdv-om

Hypo klešta su samopodešavajuća i zato nije potrebno prethodno podešavanje širine čeljusti pre prihvatanja radnog predmeta.

Maksimalan prihvati (otvor čeljusti klešta) je Ø40 mm.





447/1HPP | 620172

## Klešta papagaj

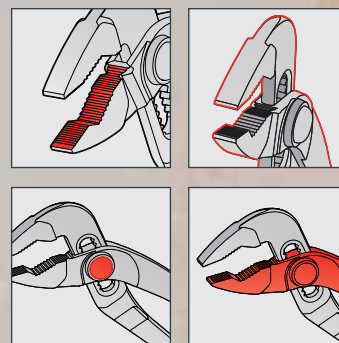

otvor čeljusti podesiv u 10 položaja

Maksimalan prihvat (otvor čeljusti klešta) je  $\varnothing 40$  mm.

3.828,00

2.871,00

3.445,00

cena sa pdv-om

447/4PHPP | 620421

## Klešta papagaj

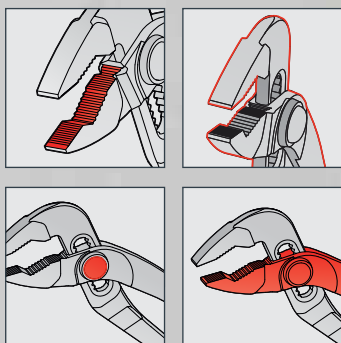

2.919,00

2.189,00

2.627,00

cena sa pdv-om

Maksimalan prihvat (otvor čeljusti klešta) je  $\varnothing 40$  mm.



407/4P | 628800

## Klešta za vijke

- za vijke dimenzija glave 3-11 mm



unutrašnjost čeljusti (prihvat) izrezbarene horizontalno i vertikalno

2.565,00

1.924,00

2.309,00

cena sa pdv-om

# KLEŠTA

461/1BI | 607884

## Sečice kose

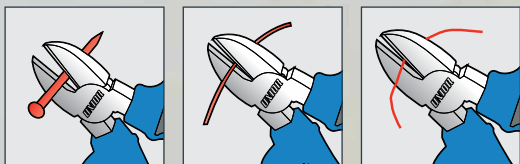

~~1.845,00~~  
1.292,00

1.550,00  
cena sa pdv-om

461/4G | 608698

## Sečice kose



~~1.460,00~~  
1.022,00

1.226,00  
cena sa pdv-om

466/4G | 608700

## Sečice kose



~~1.989,00~~  
1.492,00

1.790,00  
cena sa pdv-om

466/1BI | 608850

## Sečice kose

|                               |                              |
|-------------------------------|------------------------------|
| max 2150 N/mm <sup>2</sup> Ø† | max 650 N/mm <sup>2</sup> Ø† |
| 1,8                           | 3,0                          |



~~2.580,00~~  
1.935,00

2.322,00  
cena sa pdv-om

467SHARK/4DP | 626490

## Klešta sečice POWERSHARK



za precizno sečenje mekih (prečnika do 6 mm), tvrdih (prečnika do 3,5 mm) i tzv. "piano" žica (prečnika do 3 mm)

~~3.648,00~~  
2.554,00

3.065,00  
cena sa pdv-om

469SHARK/4DP | 626500

## Sečice sa žlebom "BOLTSHARK"

Za precizno sečenje mekih (do 6 mm), tvrdih (do 4 mm) i "piano" žica (do 3,6 mm).

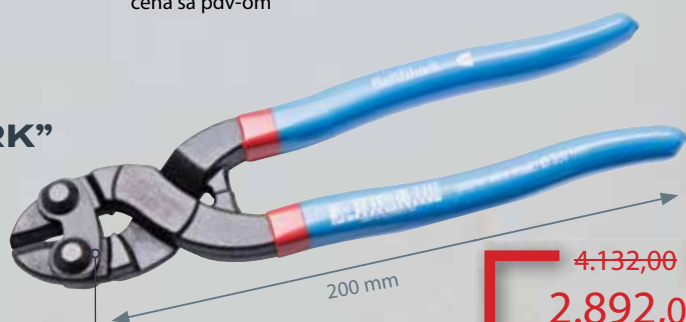

~~4.132,00~~  
2.892,00

3.470,00  
cena sa pdv-om

MADE FOR WORK.

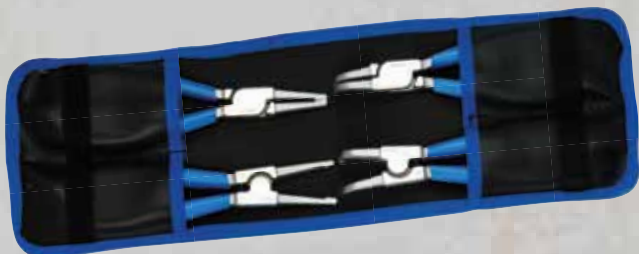

539PLUS/1PCT

## Klešta za seger prstenove u torbici

cena sa pdv-om

|        |                 |                     |          |          |
|--------|-----------------|---------------------|----------|----------|
| 621624 | 140 (10 - 25mm) | <del>8.088,00</del> | 5.662,00 | 6.794,00 |
| 621623 | 140 (3 - 13mm)  | <del>8.088,00</del> | 5.662,00 | 6.794,00 |
| 621625 | 180             | <del>8.629,00</del> | 6.040,00 | 7.248,00 |

514/1BI | 612782

## Klešta električarska višenamenska

~~2.182,00~~  
1.527,00

1.832,00  
cena sa pdv-om

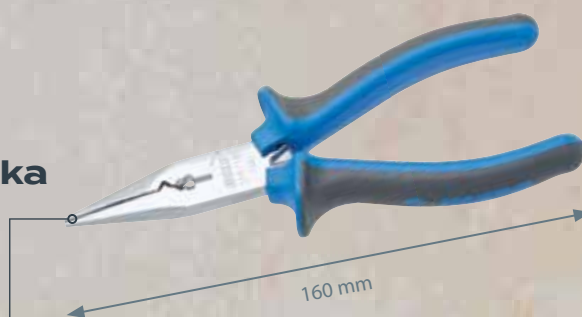

6 različitih funkcija



klešta se mogu koristiti za krimpovanje izolovanih igličastih kontakata



skidanje izolacije od Ø2,2 mm do Ø3,0 mm



skidanje izolacije od Ø3,5 mm do Ø4,0 mm



nazubljene čeljusti sprečavaju proklizavanje i omogućavaju bolji prihvat kablova, žice, itd.



krimpovanje kablovskih kontakata do Ø 4,0 mm



nazubljene čeljusti sprečavaju proklizavanje i omogućavaju bolji prihvat kablova, žice, itd.

380 | 610925

## Klešta za skidanje izolacije

- automatsko skidanje izolacija na provodnicima od 0,2 - 6 mm<sup>2</sup>

~~4.016,00~~  
3.012,00

3.614,00  
cena sa pdv-om



podešavanje dužine rezanja od 5 - 12 mm

lako pristupačan deo za sečenje žice do 2 mm

580/1BI | 609238

## Makaze za odsecanje kablova

- za sečenje kablova bez čelične žice do 10 mm



3.594,00  
**2.696,00**

**3.235,00**  
 cena sa pdv-om



1018A | 628819

## Set alata VDE, premijum



1113 (460x270x400), 110/2VDEDP (10, 13, 14, 17, 19, 22), 180/2VDEDP (10, 13, 14, 17, 19, 22), 190.1AVDEDP (1/2"), 190.4/2VDEDP (1/2"x125), 190.4/2VDEDP (1/2"x250), 190.5/2VDEDP (250), 190/2LVDEDP (10, 11, 12, 13, 14, 17, 19, 22, 24), 385AVDEDP (180), 385H (4 - 28), 406/1VDEBI (180), 447/1VDEBI (240), 466/1VDEBI (180), 467SHARK/4DP (250), 478/1VDEBI (160), 514/1BI (160), 580/1VDEBI (230), 603VDETB (0.4 x 2.5x75, 0.8 x 4.0x100, 1.0 x 5.5x125, 1.2 x 6.5x150), 613VDETB (PH1x80, PH2x100), 630VDE (0.6 x 3.5x180)

103.490,00  
**62.094,00**

**74.513,00**  
 cena sa pdv-om

MADE FOR WORK.

# UNIOR izolovani VDE alati obezbeđuju maksimalnu zaštitu.

1000V  
IEC 60900

Ručni alat za rad pod naponom do 1000V A.C.



Znak sertifikacionog tela za izolaciju (VDE)



Oznaka na alatu označava da je alat u saglasnosti sa propisanim standardima (DIN), koji preporučuju osnovne zahteve za alate (dimenzije, tvrdoće, mehanička ispitivanja,...)

406/1VDEBI | 610422

## Klešta kombinovana

2.265,00  
1.586,00

1.903,00  
cena sa pdv-om



## Sečice kose



2.364,00  
1.655,00

1.986,00  
cena sa pdv-om

6 kom



603CS6AVDE | 617655



## Odvijači VDE u garnituri

603VDE (0.4 x 2.5x75, 0.5 x 3.0x100, 0.8 x 4.0x100, 1.0 x 5.5x125), 613VDE (PH1x80, PH2x100)

3.744,00  
2.808,00

3.370,00  
cena sa pdv-om

6 kom



6 kom

2.832,00  
1.982,00

2.378,00  
cena sa pdv-om



603CS6TVDE | 617045



## Odvijači VDE i ispitivač napona u garnituri

603VDE (0.8 x 4.0x100, 1.0 x 5.5x125, 1.2 x 6.5x150),  
613VDE (PH1x80, PH2x100),  
630VDE (0.5 x 3.0x140)

603CS6TVDEBTBI | 617043

## Odvijači VDE TBI i ispitivač napona u garnituri

603VDEBTBI (0.8 x 4.0x100, 1.0 x 5.5x125, 1.2 x 6.5x150),  
613VDEBTBI (PH1x80, PH2x100),  
630VDE (0.5 x 3.0x140)

# ODVIJAČI I KOFERI

53 kom



89.160,00  
**53.496,00**  
 64.195,00  
 cena sa pdv-om

971/2VDE | 608541

Alat u koferu

1000T, 969S (500x420x200)

62 kom



81.882,00  
**49.129,00**  
 58.955,00  
 cena sa pdv-om

971/3VDE | 612548

Alat u koferu

1000AD, 969S (500x420x200)

5 kom



3.461,00  
**2.596,00**  
 3.115,00  
 cena sa pdv-om

600CS5TBI | 614007

Odvijači TBI sa OK ojačanjem u garnituri

605TBI (0.8 x 4.0x100), 
 600TBI (1.0 x 5.5x100, 1.2 x 6.5x125), 
 616TBI (PH 1x80, PH 2x100)

5 kom



2.081,00  
**1.457,00**  
 1.748,00  
 cena sa pdv-om

606CS5CR | 617017

Odvijači CR u garnituri

605CR (0.5 x 3.0x80, 0.8 x 4.0x100, 1.0 x 5.5x125, 1.2 x 6.5x150, 1.2 x 8.0x175)

7 kom



4.343,00  
**3.040,00**  
 3.648,00  
 cena sa pdv-om

621CS7TBI | 612300

Odvijači TBI sa TX profilom u garnituri

621TBI (TX 10, TX 15, TX 20, TX 25, TX 27, TX 30, TX 40)

5 kom



1.464,00  
**952,00**  
 1.142,00  
 cena sa pdv-om

607B5NI | 617037

Odvijači NI u garnituri

605NI (0.5 x 3.0x80, 0.8 x 4.0x100, 1.2 x 6.5x150), 
 615NI (PH 1x80, PH 2x100)

MADE FOR WORK.

**Vrhunski kvalitet i ergonomski oblik obezbeđuju odličan prihvat i prijanjanje u ruci.**

Ergonomomska rucka za CR i NI

Trokomponentna TBI drška

Prihvat otporan na proklizavanje

**7 kom**



**607CS7E | 620960**

**Odvijači za elektroniku u garnituri**

— **605E** (0.3 x 1.8x60, 0.4 x 2.5x75, 0.5 x 3.0x100, 0.8 x 4.0x100), — **615E** (PH 00x60, PH 0x60, PH 1x80)

~~3.159,00~~

**2.211,00**

**2.653,00**

cena sa pdv-om

**402A | 617818**

**Set klešta u kartonskoj kutiji**

— **406/1BI** (180), — **461/1BI** (160), — **445/1BI** (240)

~~6.197,00~~

**4.648,00**

**5.578,00**

cena sa pdv-om

**3 kom**



**402B | 617933**

**Set klešta u kartonskoj kutiji**

— **406/4G** (180), — **461/4G** (160), — **445/4G** (240)

~~4.889,00~~

**3.667,00**

**4.400,00**

cena sa pdv-om

**3 kom**



# ALAT ZA VODOINSTALATERE

482/6

## Klešta za cevi kosa 45°, čeljusti S-oblika



cena sa pdv-om

|        | ⌀      | ⌀ <sup>max</sup> | L   |                      |          |           |
|--------|--------|------------------|-----|----------------------|----------|-----------|
| 601511 | 1"     | 50               | 335 | <del>3.401,00</del>  | 2.551,00 | 3.061,00  |
| 601512 | 1.1/2" | 60               | 430 | <del>4.487,00</del>  | 3.365,00 | 4.038,00  |
| 601510 | 1/2"   | 35               | 265 | <del>2.842,00</del>  | 2.132,00 | 2.558,00  |
| 601513 | 2"     | 80               | 545 | <del>7.420,00</del>  | 5.194,00 | 6.233,00  |
| 601514 | 3"     | 105              | 700 | <del>13.272,00</del> | 9.290,00 | 11.148,00 |



400 | 612599

## Set klešta za cevi u kartonskoj kutiji

482/6 (1", 1.1/2"), 447/6 (240)

~~11.009,00~~

8.257,00

9.908,00

cena sa pdv-om



360/6A | 626187

## Rezač cevi

- brza zamena sečiva
- 4 rolera za bolje prijanjanje na cev i lakšu upotrebu
- moguće korišćenje NOGA alata za ravnjanje površina reza

626187 | 3-35mm



~~4.455,00~~

3.341,00

4.009,00

cena sa pdv-om





596/6A

## Makaze za betonsko gvožđe

ublaživači udara (odstojnici) na zglobovima ublažavaju vibracije nastale pri rezanju jako tvrdih materijala



cena sa pdv-om

|        | L     | max 1600 N/mm <sup>2</sup> Ø† | max 650 N/mm <sup>2</sup> Ø† |           |           |           |
|--------|-------|-------------------------------|------------------------------|-----------|-----------|-----------|
| 610965 | 450mm | 5                             | 8                            | 7.202,00  | 5.041,00  | 6.049,00  |
| 610966 | 600mm | 7                             | 10                           | 9.417,00  | 6.592,00  | 7.910,00  |
| 610967 | 750mm | 8                             | 13                           | 12.344,00 | 8.641,00  | 10.369,00 |
| 610968 | 900mm | 9                             | 16                           | 16.739,00 | 11.717,00 | 14.060,00 |

531/4

## Klešta armiračka



L

cena sa pdv-om

|        |       |          |          |          |
|--------|-------|----------|----------|----------|
| 601373 | 224mm | 1.384,00 | 969,00   | 1.163,00 |
| 601374 | 250mm | 1.544,00 | 1.081,00 | 1.297,00 |
| 601375 | 280mm | 1.773,00 | 1.241,00 | 1.489,00 |

# Pneumatski alati nude EFIKASNO, BEZBEDNO i JEDNOSTAVNO rešenje.

1/2"



max. obrtni moment: 814 Nm

1561 | 615322

## Odvrtič pneumatski 1/2"

- 8.000 o/min u slobodnom hodu
- max. pritisak vazduha: 6, 2 bara
- potrošnja vazduha: 113 l/min
- priključak za vazduh: 1/4"
- za vijke do M16

~~25.028,00~~

15.017,00

18.020,00  
cena sa pdv-om

1562 | 615321

## Odvrtič pneumatski 1/2"

- 7.000 o/min u slobodnom hodu
- max. pritisak vazduha: 6, 2 bara
- potrošnja vazduha: 119 l/min
- priključak za vazduh: 1/4"
- za vijke do M18

~~31.503,00~~

18.902,00

22.682,00  
cena sa pdv-om

1/2"



max. obrtni moment: 949 Nm

1"

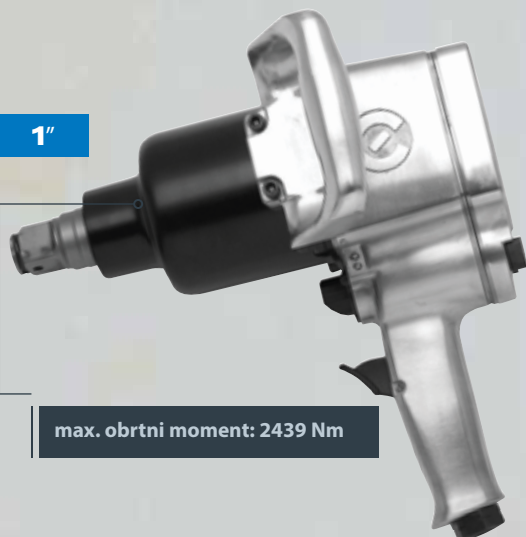

max. obrtni moment: 2439 Nm

1592 | 615326

## Odvrtič pneumatski 1"

- 4.000 o/min u slobodnom hodu
- max. pritisak vazduha: 6, 2 bara
- potrošnja vazduha: 340 l/min

~~116.015,00~~

69.609,00

83.531,00  
cena sa pdv-om



1/2"

max. obrtni moment: 1223 Nm

kompozitno kućište

sa regulatorom za 3 različite brzine zavrtnja/odvrtnja

1566 | 627570

**Odvrtlač pneumatski 1/2"**

- 8.000 o/min u slobodnom hodu
- max. pritisak vazduha: 6, 2 bara
- potrošnja vazduha: 113 l/min
- priključak za vazduh: 1/4"
- za vijke do M24

~~26.504,00~~  
**15.902,00**

**19.082,00**  
cena sa pdv-om



1/2"

max. obrtni moment: 745 Nm

~~22.318,00~~  
**13.391,00**

**16.069,00**  
cena sa pdv-om

1563 | 627568

**Odvrtlač pneumatski, kompozitni, prihvat 1/2"**

- 8.000 o/min u slobodnom hodu
- preporučeni pritisak dovoda vazduha: 6,2 bar
- potrošnja komprimovanog vazduha: 164 l/min
- za vijke do M20
- UVEK koristite Uniorove IMPACT nasadne ključeve i pribor



3/4"

max. obrtni moment: 2034 Nm

~~55.792,00~~  
**33.475,00**

**40.170,00**  
cena sa pdv-om

1573 | 627571

**Odvrtlač pneumatski 3/4"**

- 5.500 o/min u slobodnom hodu
- max. pritisak vazduha: 6, 2 bara
- potrošnja vazduha: 198 l/min
- priključak za vazduh: 3/8"
- za vijke do M30

MADE FOR WORK.

556A | 616853

## Skalpel



3 izmenljiva segmentirana noža u dršci

466,00

350,00

420,00

cena sa pdv-om

2087 | 619929

## Hvatač savitljivi sa magnetom

- sastoji se iz savitljivog stabla sa jakim magnetom na vrhu
- magnet može da podiže metalne predmete težine do 1 kg
- ergonomska drška omogućuje laku i efikasnu upotrebu

2.018,00

1.514,00

1.817,00

cena sa pdv-om



710P

## Merna traka



čelična merna traka

klasa tačnosti II

cena sa pdv-om

|        |     |          |          |          |
|--------|-----|----------|----------|----------|
| 612133 | 5m  | 915,00   | 686,00   | 823,00   |
| 612134 | 8m  | 1.623,00 | 1.217,00 | 1.460,00 |
| 612135 | 10m | 2.057,00 | 1.543,00 | 1.852,00 |

2091 | 620237

## LED svetiljka

5.533,00

3.320,00

3.984,00

cena sa pdv-om

6 LED dioda na prednjoj strani može biti uključeno približno 3 sata, a 1 LED dioda na vrhu 7 sati



### UNIORTEOS ALATI D.O.O. BEOGRAD

Subotička 23

11050 Zvezdara

T: +381 11 744 03 30

[www.uniorteos.rs](http://www.uniorteos.rs)

[office@uniorteos.com](mailto:office@uniorteos.com)

3<sup>godina</sup> **UNIORTEOS**<sup>®</sup>  
1995 - 2025 stvarno dobri alati